

SL1- SLV



Pompes d'assainissement en fonte à usage collectif

Description générale

Pompes de haute qualité destinées au pompage d'eaux usées, d'eaux de process et d'effluents bruts non dégrillés de collectivités, de communes ou d'industries. Elles doivent être submergées. Les pompes SL ne disposent pas de chemise de refroidissement. Les roues à haut rendement monocanale ou SuperVortex ont un passage libre jusqu'à 100 mm.

Caractéristiques techniques

Débit, Q : 312 m³/h maxi
 Hauteur, H : 42 m maxi
 Temp. liquide : 0°C à +40°C
 Dim. particules : Ø 100 mm maxi
 Puissances moteur : de 1.1 à 11 kW
 Classe d'isolation : F
 Indice de protection : IP68

Applications

- Relevage des eaux de surface,
- Relevage des eaux usées collectives contenant des fibres,
- Relevage des eaux usées contenant de la boue,
- Relevage des eaux industrielles.

Matériaux / Construction

Description	Matériaux
Roue mobile	Fonte
Corps de pompe	Fonte
Collier	Acier inoxydable
Garniture mécanique à cartouche	Garniture primaire : SiC /SiC Garniture secondaire : carbone/céramique
Arbre / Rotor	Acier / Acier inoxydable

Désignation

Code exemple	SL 1	.80	.80	.40	.A	.EX	.4	.5	OD
Type Pompes d'assainissement									
Type de roue 1 Monocanale V SuperVortex									
80 Passage libre (mm)									
80 Diamètre nominal de refoulement (mm)									
Puissance sur arbre 40 P2/100 [W]									
Équipement (avec ou sans capteur) A Avec capteurs ou boîtier de commande CU100									
Version EX (anti-déflagrante) EX Pompe homologuée à la norme ATEX [] Version standard									
Pôle moteur Indique la vitesse du moteur à 50 Hz 2 2 pôles 3000 4 4 pôles 1500									
Alimentation 1 Monophasé [] Triphasé									
Fréquence 5 50Hz									
Tensions et méthode de démarrage 02 230 V, direct 0D 380-415 V, direct 1D 380-415 V, étoile triangle SD 0B 400-415 V, direct 0C, 230-240 V, direct									

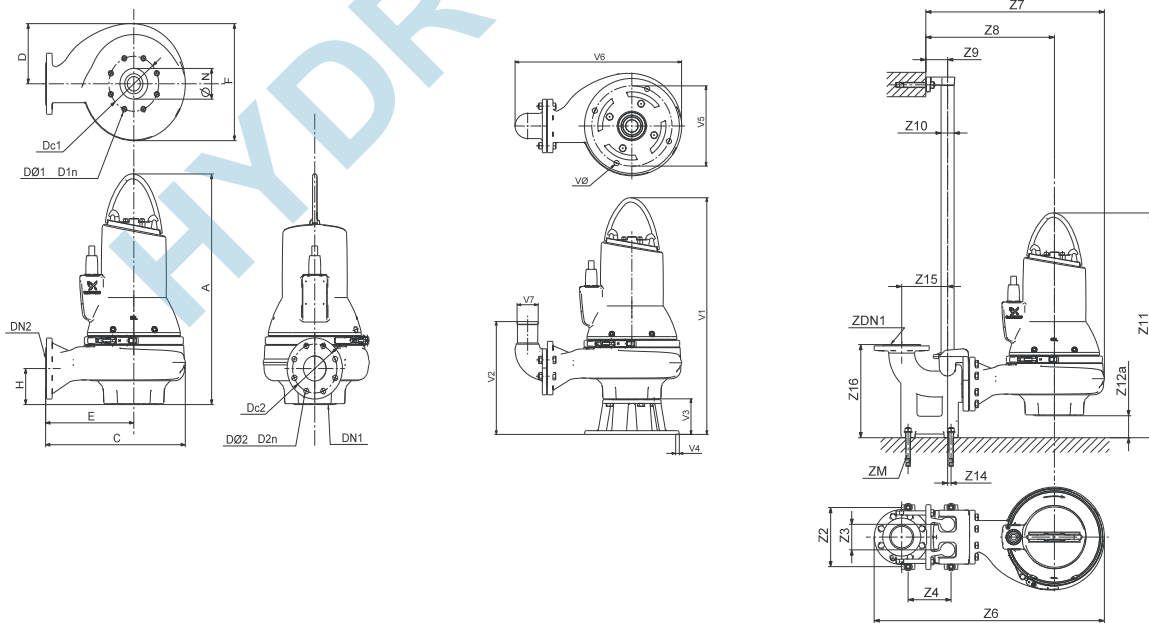
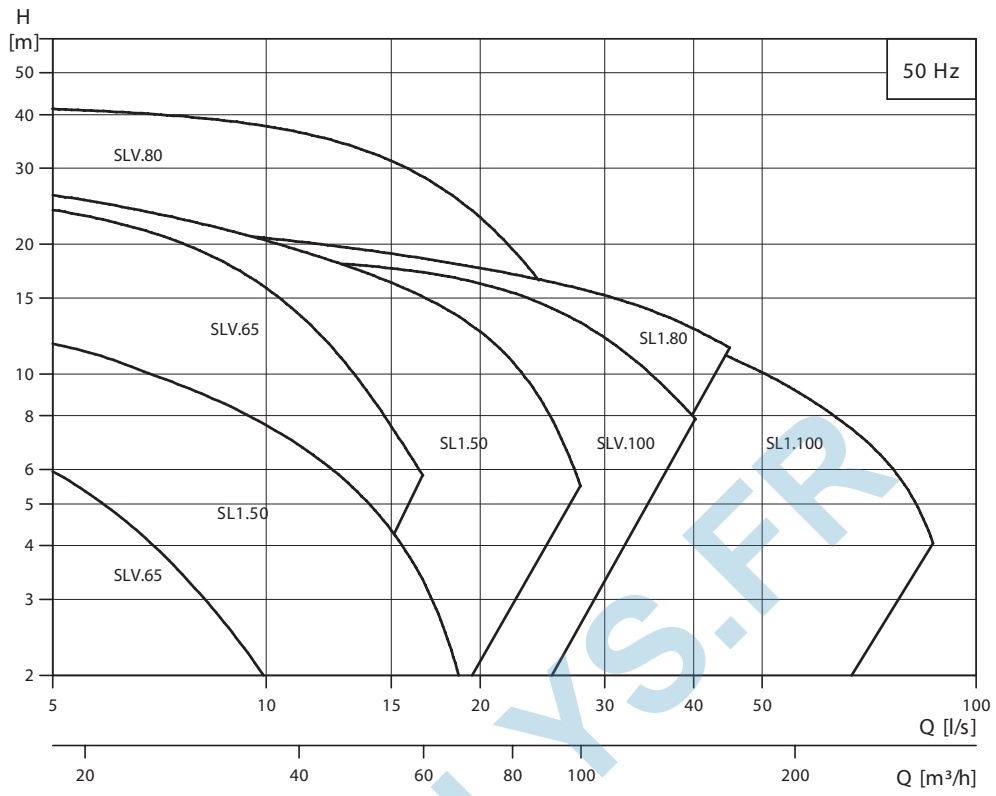

TM04 2793 3008/TM04 2794 3008/TM04 2795 3008/TM04 3473 4608

Plage de performances

Caractéristiques électriques

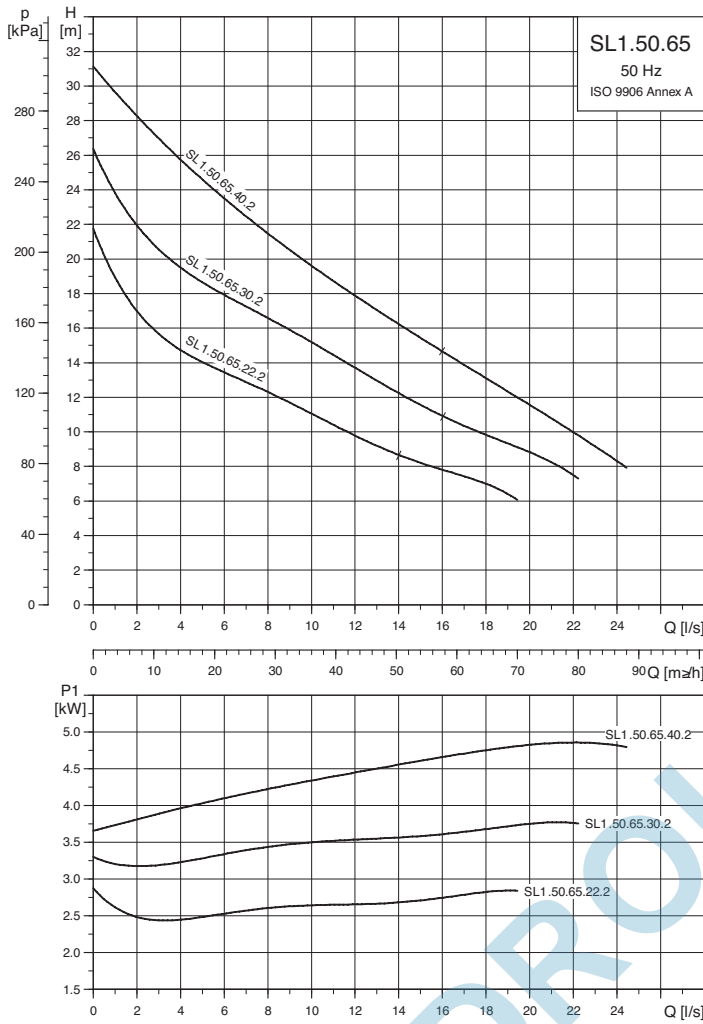

Type de pompe	Tension [V]	P1 [kW]	P2 [kW]	I _{1/1} [A]	n [min ⁻¹]
SL1.50.65.22.2	3 x 400	2.8	2.2	4.9	2990
SL1.50.65.30.2	3 x 400	3.8	3.0	6.8	2910
SL1.50.65.40.2	3 x 400	4.8	4.0	8.5	2930

Type de pompe	Dimensions [mm]																
	A	C	D	E	F	H	DN1	Dc1	Dt1	DØ1	D1n	DN2	Dc2	Dt2	DØ2	D2n	Poids
SL1.50.65.22.2	641	366	171	216	321	93	65	145	18	4 x 18	65	145	18	4 x 18	86		
SL1.50.65.30.2	641	366	171	216	321	93	65	145	18	4 x 18	65	145	18	4 x 18	89		
SL1.50.65.40.2	677	407	200	227	379	93	65	145	18	4 x 18	65	145	18	4 x 18	115		
Type de pompe	Dimensions [mm]																
	Z2	Z3	Z4	Z6	Z7	Z8	Z9	Z11	Z12a	Z14	Z15	Z16	Z10	Dc1	DN1	ZM	
SL1.50.65.22.2	210	95	140	700	513	363	81	740	99	1	175	266	1 1/2 "	145	65	4 x M16	
SL1.50.65.30.2	210	95	140	700	513	363	81	740	99	1	175	266	1 1/2 "	145	65	4 x M16	
SL1.50.65.40.2	210	95	140	741	554	375	81	774	97	1	175	266	1 1/2 "	145	65	4 x M16	
Type de pompe	Dimensions [mm]																
	V1	V2	V3	V4	V5	V6	V7	VØ									
SL1.50.65.22.2	771	339	130	325	270	491	65	18									
SL1.50.65.30.2	771	339	130	325	270	491	65	18									
SL1.50.65.40.2	807	341	130	325	270	519	65	18									

Plage de performances

Caractéristiques électriques

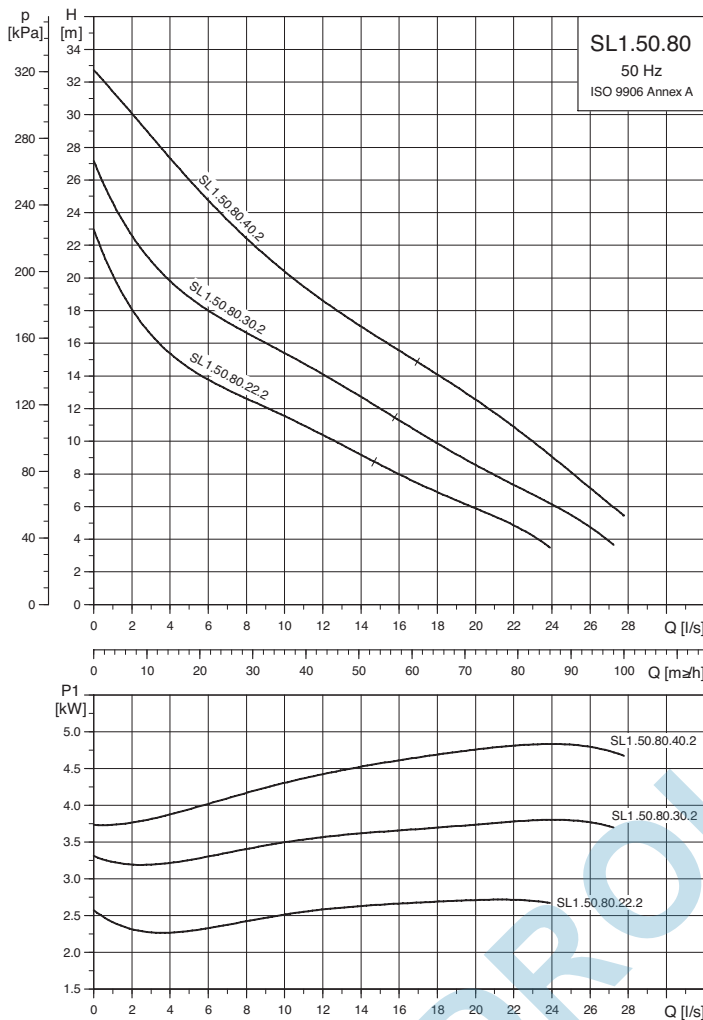

Type de pompe	Tension [V]	P1 [kW]	P2 [kW]	I _{1/1} [A]	n [min ⁻¹]
SL1.50.80.22.2	3 x 400	2.8	2.2	4.9	2990
SL1.50.80.30.2	3 x 400	3.8	3.0	6.8	2910
SL1.50.80.40.2	3 x 400	4.8	4.0	8.5	2930

Type de pompe	Dimensions [mm]																
	A	C	D	E	F	H	DN1	Dc1	Dt1	DØ1	D1n	DN2	Dc2	Dt2	DØ2	D2n	Poids
SL1.50.80.22.2	641	366	171	216	321	100	65	145	18	4 x 18	80	160	20	8 x 18	87		
SL1.50.80.30.2	641	366	171	216	321	100	65	145	18	4 x 18	80	160	20	8 x 18	90		
SL1.50.80.40.2	677	407	200	227	379	100	65	145	18	4 x 18	80	160	20	8 x 18	94		
Type de pompe	Dimensions [mm]																
	Z2	Z3	Z4	Z6	Z7	Z8	Z9	Z11	Z12a	Z14	Z15	Z16	Z10	Dc1	DN1	ZM	
SL1.50.80.22.2	220	95	160	719	526	376	81	774	133	13	171	345	1 1/2 "	145	65	4 x M16	
SL1.50.80.30.2.50D	220	95	160	719	526	376	81	774	133	13	171	345	1 1/2 "	145	65	4 x M16	
SL1.50.80.40.2	220	95	160	760	567	387	81	808	132	13	171	345	1 1/2 "	145	65	4 x M16	
Type de pompe	Dimensions [mm]																
	V1	V2	V3	V4	V5	V6	V7	VØ									
SL1.50.80.22.2	771	339	130	325	270	496	80	18									
SL1.50.80.30.2	771	339	130	325	270	496	80	18									
SL1.50.80.40.2	807	341	130	325	270	525	80	18									

Plage de performances

Caractéristiques électriques

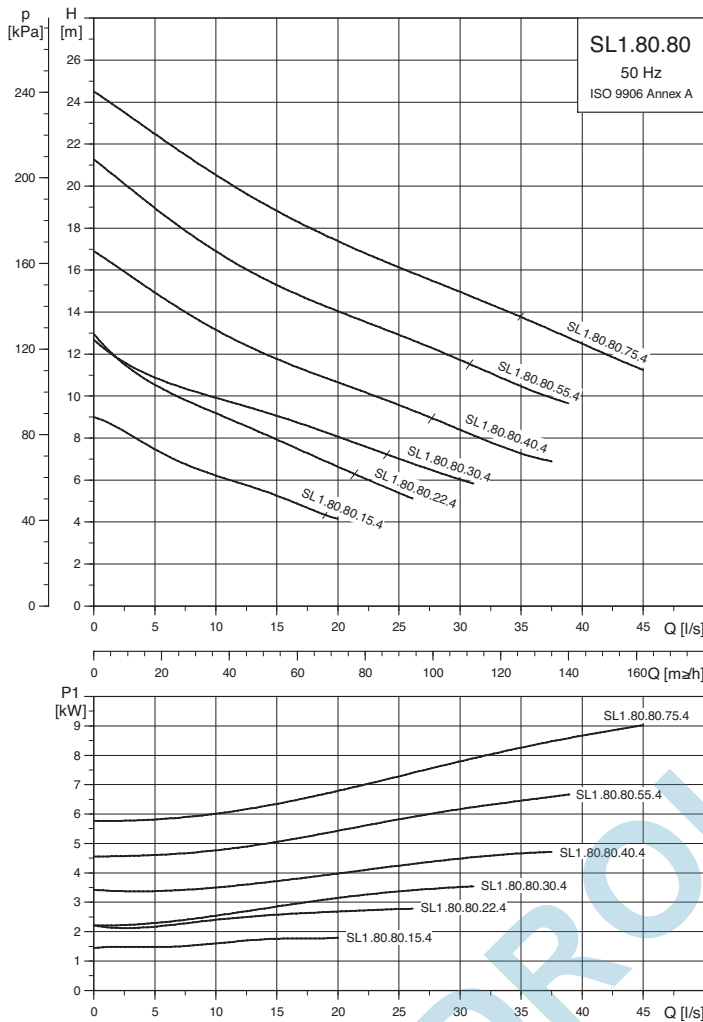

Type de pompe	Tension [V]	P1 [kW]	P2 [kW]	I _{1/1} [A]	n [min-1]
SL1.80.80.15.4	3 x 400	2.1	1.5	3.9	1450
SL1.80.80.22.4	3 x 400	2.9	2.2	5.3	1460
SL1.80.80.30.4	3 x 400	3.7	3.0	7.2	1450
SL1.80.80.40.4	3 x 400	4.8	4.0	9.7	1460
SL1.80.80.55.4	3 x 400	6.4	5.5	11.8	1460
SL1.80.80.75.4	3 x 400	8.6	7.5	15.2	1460

Type de pompe	Dimensions [mm]															
	A	C	D	E	F	H	DN1	Dc1	Dt1	DØ1	D1n	DN2	Dc2	Dt2	DØ2	D2n
SL1.80.80.15.4	682	435	171	272	347	100	100	180	20	8 x 18	80	160	20	8 x 18	95	
SL1.80.80.22.4	682	435	171	272	347	100	100	180	20	8 x 18	80	160	20	8 x 18	107	
SL1.80.80.30.4	711	505	200	319	397	118	100	180	20	8 x 18	80	160	20	8 x 18	137	
SL1.80.80.40.4	748	505	200	319	397	118	100	180	20	8 x 18	80	160	20	8 x 18	142	
SL1.80.80.55.4	755	505	200	319	397	118	100	180	20	8 x 18	80	160	20	8 x 18	149	
SL1.80.80.75.4	818	530	217	328	423	118	100	180	20	8 x 18	80	160	20	8 x 18	193	

Type de pompe	Dimensions [mm]															
	Z2	Z3	Z4	Z6	Z7	Z8	Z9	Z11	Z12a	Z14	Z15	Z16	Z10	Dc1	DN1	ZM
SL1.80.80.15.4	220	95	160	788	595	432	81	790	108	13	171	345	1 1/2 "	180	100	4 x M16
SL1.80.80.22.4	220	95	160	788	595	432	81	790	108	13	171	345	1 1/2 "	180	100	4 x M16
SL1.80.80.30.4	220	95	160	858	666	480	81	793	82	13	171	345	1 1/2 "	180	100	4 x M16
SL1.80.80.40.4	220	95	160	858	666	480	81	830	82	13	171	345	1 1/2 "	180	100	4 x M16
SL1.80.80.55.4	220	95	160	858	666	480	81	837	82	13	171	345	1 1/2 "	180	100	4 x M16
SL1.80.80.75.4	220	95	160	883	690	489	81	900	82	13	171	345	1 1/2 "	180	100	4 x M16

Type de pompe	Dimensions [mm]							
	V1	V2	V3	V4	V5	V6	V7	VØ
SL1.80.80.15.4	812	364	130	355	300	567	80	19
SL1.80.80.22.4	812	364	130	355	300	567	80	19
SL1.80.80.30.4	841	390	130	355	300	623	80	19
SL1.80.80.40.4	878	390	130	355	300	623	80	19
SL1.80.80.55.4	885	390	130	355	300	623	80	19
SL1.80.80.75.4	948	390	130	355	300	648	80	19

Plage de performances

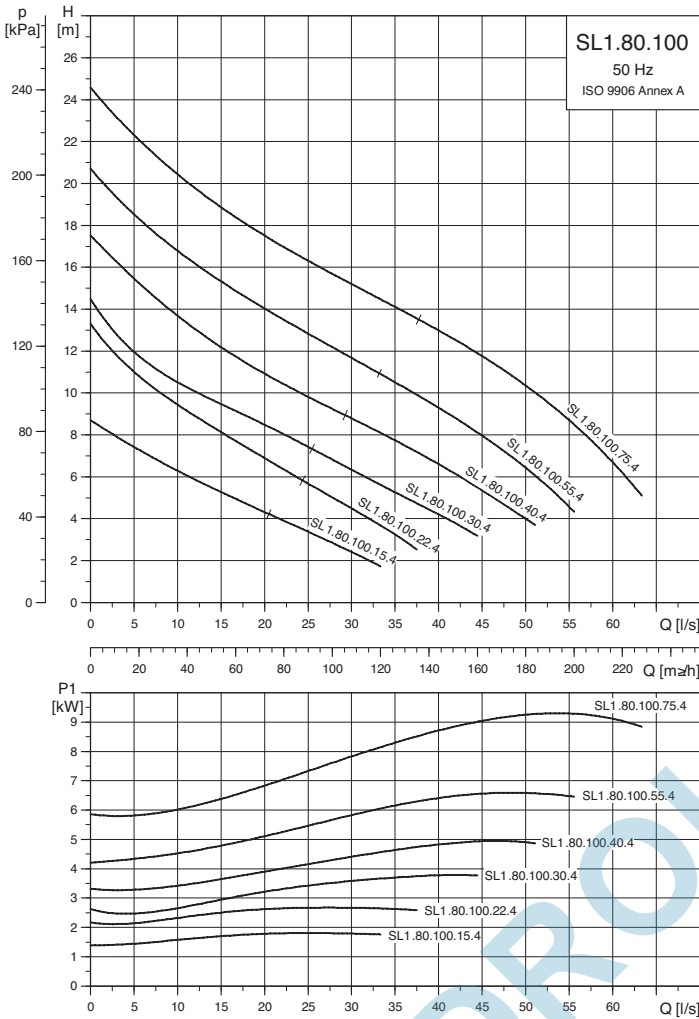

Caractéristiques électriques

Type de pompe	Tension [V]	P1 [kW]	P2 [kW]	I _{1/1} [A]	n [min-1]
SL1.80.100.15.4	3 x 400	2.1	1.5	3.9	1450
SL1.80.100.22.4	3 x 400	2.9	2.2	5.3	1460
SL1.80.100.30.4	3 x 400	3.7	3.0	7.2	1450
SL1.80.100.40.4	3 x 400	4.8	4.0	9.7	1460
SL1.80.100.55.4	3 x 400	6.4	5.5	11.8	1460
SL1.80.100.75.4	3 x 400	8.6	7.5	15.2	1460

Type de pompe	Dimensions [mm]																
	A	C	D	E	F	H	DN1	Dc1	Dt1	DØ1	D1n	DN2	Dc2	Dt2	DØ2	D2n	Poids
SL1.80.100.15.4	682	435	171	272	347	112	100	180	20	8 x 18	100	180	180	20	8 x 18	100	96
SL1.80.100.22.4	682	435	171	272	347	112	100	180	20	8 x 18	100	180	180	20	8 x 18	100	108
SL1.80.100.30.4	726	505	200	319	397	118	100	180	20	8 x 18	100	180	180	20	8 x 18	100	139
SL1.80.100.40.4	748	505	200	319	397	118	100	180	20	8 x 18	100	180	180	20	8 x 18	100	139
SL1.80.100.55.4	755	505	200	319	397	118	100	180	20	8 x 18	100	180	180	20	8 x 18	100	150
SL1.80.100.75.4	818	530	217	328	423	118	100	180	20	8 x 18	100	180	180	20	8 x 18	100	194

Type de pompe	Dimensions [mm]															
	Z2	Z3	Z4	Z6	Z7	Z8	Z9	Z11	Z12a	Z14	Z15	Z16	Z10	Dc1	DN1	ZM
SL1.80.100.15.4	260	110	270	878	652	489	110	830	148	0	220	413	2"	180	100	4
SL1.80.100.22.4	260	110	270	878	652	489	110	830	148	0	220	413	2"	180	100	4
SL1.80.100.30.4	260	110	270	948	722	536	110	830	122	0	220	413	2"	180	100	4
SL1.80.100.40.4	260	110	270	948	722	536	110	870	122	0	220	413	2"	180	100	4
SL1.80.100.55.4	260	110	270	948	722	536	110	870	122	0	220	413	2"	180	100	4
SL1.80.100.75.4	260	110	270	972	747	545	110	940	122	0	220	413	2"	180	100	4

Type de pompe	Dimensions [mm]							
	V1	V2	V3	V4	V5	V6	V7	VØ
SL1.80.100.15.4	812	369	130	355	300	591	100	19
SL1.80.100.22.4	812	369	130	355	300	591	100	19
SL1.80.100.30.4	856	395	130	355	300	647	100	19
SL1.80.100.40.4	878	395	130	355	300	647	100	19
SL1.80.100.55.4	885	395	130	355	300	647	100	19
SL1.80.100.75.4	948	395	130	355	300	672	100	19

Plage de performances

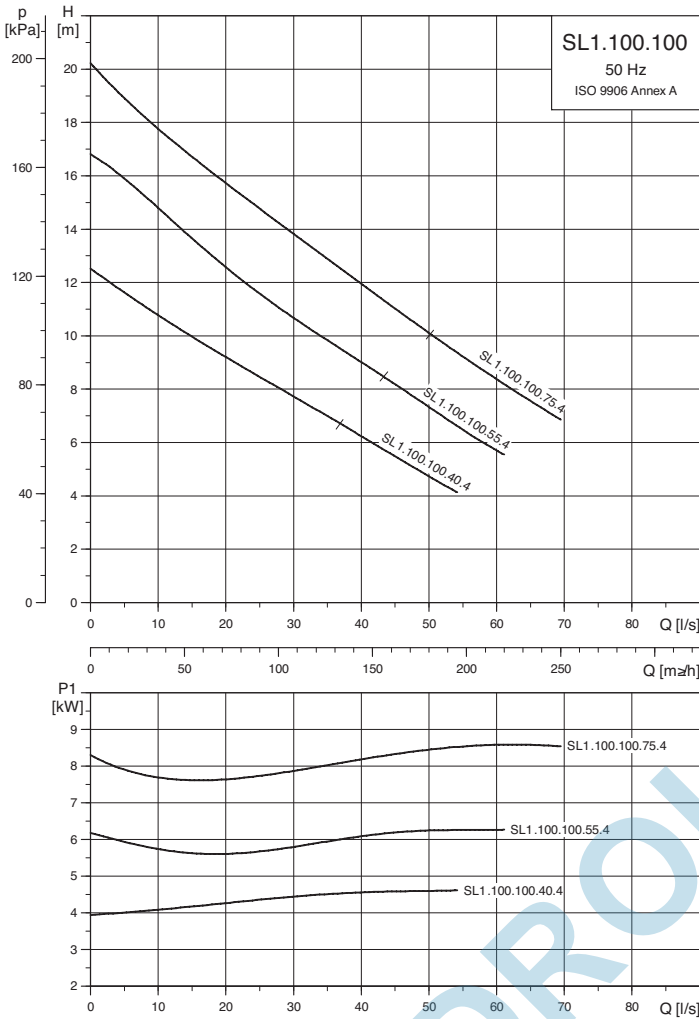

Caractéristiques électriques

Type de pompe	Tension [V]	P1 [kW]	P2 [kW]	I _{1/1} [A]	n [min ⁻¹]
SL1.100.100.40.4	3 x 400	4.8	4.0	9.7	1460
SL1.100.100.55.4	3 x 400	6.4	5.5	11.8	1460
SL1.100.100.75.4	3 x 400	8.6	7.5	15.2	1460

Type de pompe	Dimensions [mm]																
	A	C	D	E	F	H	DN1	Dc1	Dt1	DØ1	D1n	DN2	Dc2	Dt2	DØ2	D2n	Poids
SL1.100.100.40.4	755	541	200	320	438	115	150	240	22	8 x 22	100	180	20	8 x 18	155		
SL1.100.100.55.4	762	541	200	320	438	115	150	240	22	8 x 22	100	180	20	8 x 18	161		
SL1.100.100.75.4	827	541	217	312	462	115	150	240	22	8 x 22	100	180	20	8 x 18	202		
Type de pompe	Dimensions [mm]																
	Z2	Z3	Z4	Z6	Z7	Z8	Z9	Z11	Z12a	Z14	Z15	Z16	Z10	Dc1	DN1	ZM	
SL1.100.100.40.4	260	110	270	983	758	537	110	879	125	0	220	413	2"	240	150	4 x M16	
SL1.100.100.55.4	260	110	270	983	758	537	110	886	125	0	220	413	2"	240	150	4 x M16	
SL1.100.100.75.4	260	110	270	983	758	529	110	951	125	0	220	413	2"	240	150	4 x M16	
Type de pompe	Dimensions [mm]																
	V1	V2	V3	V4	V5	V6	V7	VØ									
SL1.100.100.40.4	941	445	186	450	400	711	100	22									
SL1.100.100.55.4	948	445	186	450	400	711	100	22									
SL1.100.100.75.4	1013	445	186	450	400	706	100	22									

Plage de performances

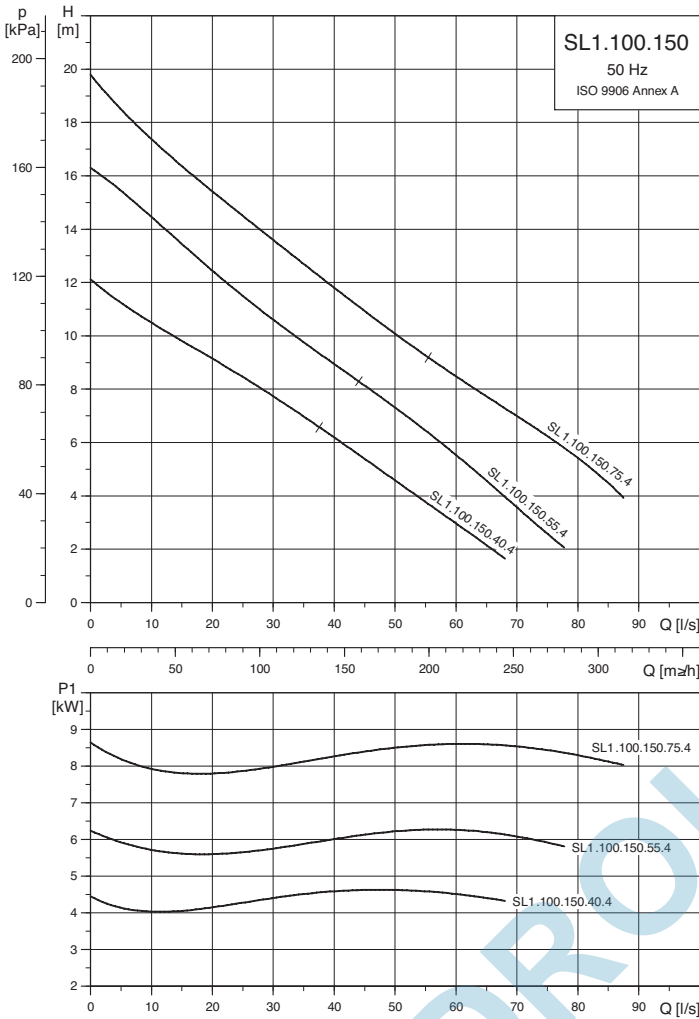

Caractéristiques électriques

Type de pompe	Tension [V]	P1 [kW]	P2 [kW]	I _{1/1} [A]	n [min ⁻¹]
SL1.100.150.40.4	3 x 400	4.8	4.0	9.7	1460
SL1.100.150.55.4	3 x 400	6.4	5.5	11.8	1460
SL1.100.150.75.4	3 x 400	8.6	7.5	15.2	1460

Type de pompe	Dimensions [mm]																
	A	C	D	E	F	H	DN1	Dc1	Dt1	DØ1	D1n	DN2	Dc2	Dt2	DØ2	D2n	Poids
SL1.100.150.40.4	755	541	200	320	440	143	150	240	22	8 x 22	150	240	22	8 x 22	157		
SL1.100.150.55.4	762	541	200	320	440	143	150	240	22	8 x 22	150	240	22	8 x 22	163		
SL1.100.150.75.4	827	541	217	306	472	143	150	240	22	8 x 22	150	240	22	8 x 22	204		
Type de pompe	Dimensions [mm]																
	Z2	Z3	Z4	Z6	Z7	Z8	Z9	Z11	Z12a	Z14	Z15	Z16	Z10	Dc1	DN1	ZM	
SL1.100.150.40.4	300	110	340	1093	780	559	110	919	164	0	280	450	2 "	240	150	4 x M16	
SL1.100.150.55.4	300	110	340	1093	780	559	110	926	164	0	280	450	2 "	240	150	4 x M16	
SL1.100.150.75.4	300	110	340	1093	780	545	110	991	164	0	280	450	2 "	240	150	4 x M16	
Type de pompe	Dimensions [mm]																
	V1	V2	V3	V4	V5	V6	V7	VØ									
SL1.100.150.40.4	941	555	186	450	400	807	150	22									
SL1.100.150.55.4	948	555	186	450	400	807	150	22									
SL1.100.150.75.4	1013	555	186	450	400	803	150	22									

Plage de performances

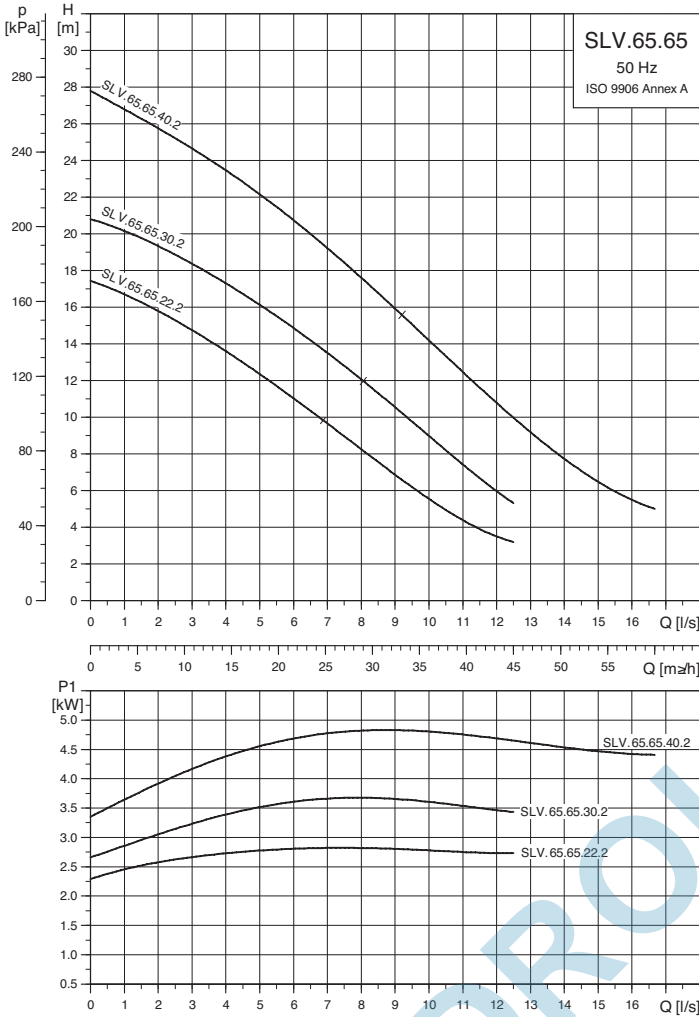

Caractéristiques électriques

Type de pompe	Tension [V]	P1 [kW]	P2 [kW]	I _{1/1} [A]	n [min ⁻¹]
SLV.65.65.22.2	3 x 400	2.8	2.2	4.9	2990
SLV.65.65.30.2	3 x 400	3.8	3.0	6.8	2910
SLV.65.65.40.2	3 x 400	4.8	4.0	8.5	2930

Type de pompe	Dimensions [mm]																
	A	C	D	E	F	H	DN1	Dc1	Dt1	DØ1	D1n	DN2	Dc2	Dt2	DØ2	D2n	Poids
SLV.65.65.22.2	684	396	171	246	321	102	80	160	20	8 x 18	65	145	18	4 x 18			88
SLV.65.65.30.2	684	396	171	246	321	102	80	160	20	8 x 18	65	145	18	4 x 18			91
SLV.65.65.40.2	718	456	200	276	380	106	80	160	20	8 x 18	65	145	18	4 x 18			117
Type de pompe	Dimensions [mm]																
	Z2	Z3	Z4	Z6	Z7	Z8	Z9	Z11	Z12a	Z14	Z15	Z16	Z10	Dc1	DN1	ZM	
SLV.65.65.22.2	210	95	140	730	543	394	81	747	63	1	175	266	1 1/2"	160	80	4 x M16	
SLV.65.65.30.2	210	95	140	730	543	394	81	747	63	1	175	266	1 1/2"	160	80	4 x M16	
SLV.65.65.40.2	210	95	140	790	604	424	81	778	60	1	175	266	1 1/2"	160	80	4 x M16	
Type de pompe	Dimensions [mm]																
	V1	V2	V3	V4	V5	V6	V7	VØ									
SLV.65.65.22.2	771	339	130	325	270	491	65	18									
SLV.65.65.30.2	771	339	130	325	270	491	65	18									
SLV.65.65.40.2	807	341	130	325	270	519	65	18									

Plage de performances

Caractéristiques électriques

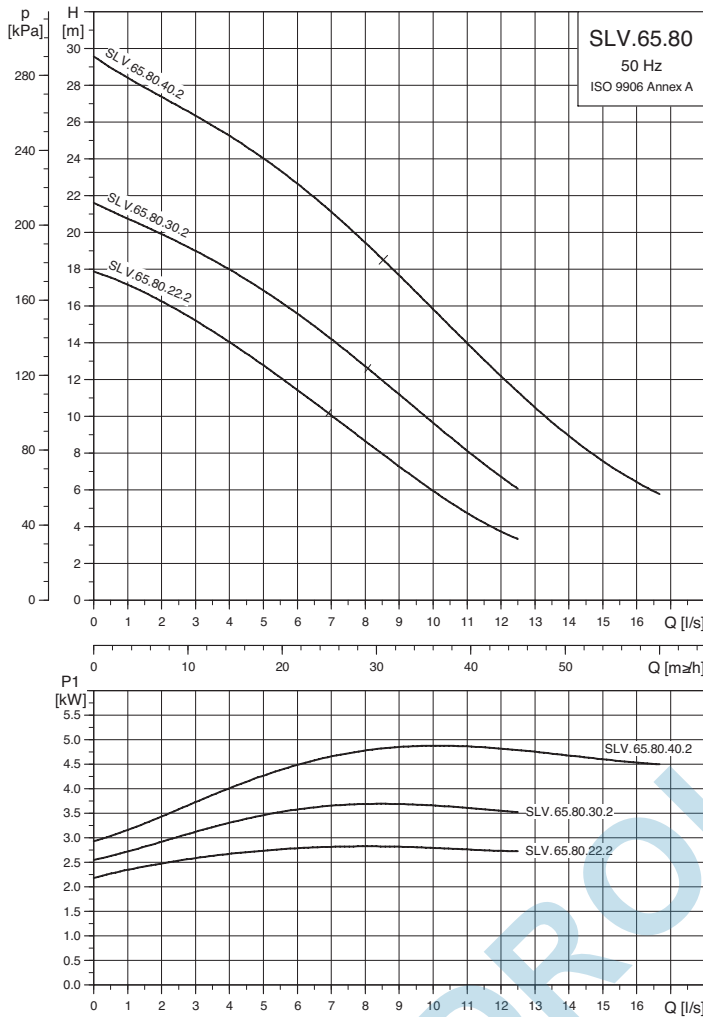

Type de pompe	Tension [V]	P1 [kW]	P2 [kW]	I _{1/1} [A]	n [min ⁻¹]
SLV.65.80.22.2	3 x 400	2.8	2.2	4.9	2990
SLV.65.80.30.2	3 x 400	3.8	3.0	6.8	2910
SLV.65.80.40.2	3 x 400	4.8	4.0	8.5	2930

Type de pompe	Dimensions [mm]															
	A	C	D	E	F	H	DN1	Dc1	Dt1	DØ1	D1n	DN2	Dc2	Dt2	DØ2	D2n
SLV.65.80.22.2	685	397	171	247	321	103	80	160	20	8 x 18	80	160	20	8 x 18	89	
SLV.65.80.30.2	685	397	171	247	321	103	80	160	20	8 x 18	80	160	20	8 x 18	92	
SLV.65.80.40.2	718	455	200	276	379	106	80	160	20	8 x 18	80	160	20	8 x 18	117	

Type de pompe	Dimensions [mm]															
	Z2	Z3	Z4	Z6	Z7	Z8	Z9	Z11	Z12a	Z14	Z15	Z16	Z10	Dc1	DN1	ZM
SLV.65.80.22.2	220	95	160	750	557	408	81	782	97	13	171	345	1 1/2"	160	80	4 x M16
SLV.65.80.30.2	220	95	160	750	557	408	81	782	97	13	171	345	1 1/2"	160	80	4 x M16
SLV.65.80.40.2	220	95	160	808	616	437	81	812	94	13	171	345	1 1/2"	160	80	4 x M16

Type de pompe	Dimensions [mm]								
	V1	V2	V3	V4	V5	V6	V7	VØ	
SLV.65.80.22.2	813	373	128	330	280	530	80	18	
SLV.65.80.30.2	813	373	128	330	280	530	80	18	
SLV.65.80.40.2	846	376	128	330	280	573	80	18	

Plage de performances

Caractéristiques électriques

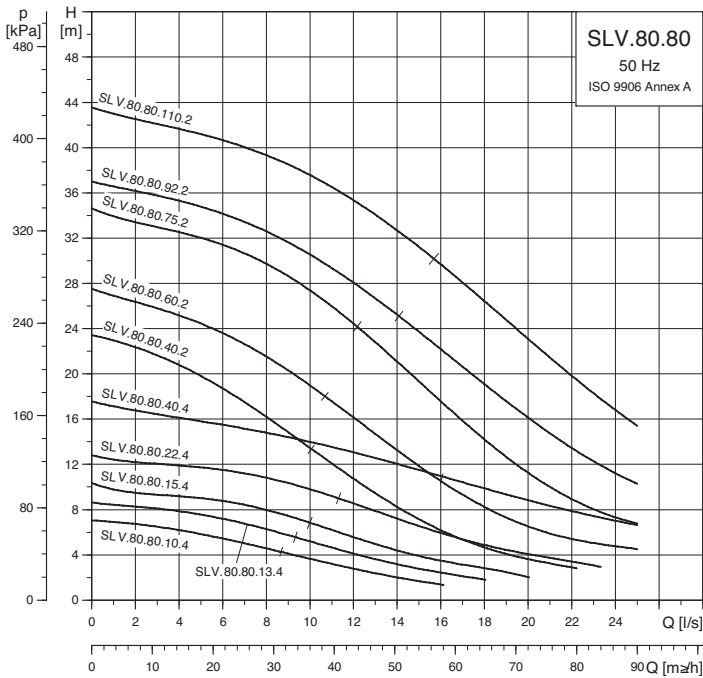

Type de pompe	Tension [V]	P1 [kW]	P2 [kW]	I _{1/1} [A]	n [min-1]
SLV.80.80.11.4	3 x 400	1.5	1.1	3.0	1450
SLV.80.80.13.4	3 x 400	1.8	1.3	3.6	1460
SLV.80.80.15.4	3 x 400	2.1	1.5	3.9	1450
SLV.80.80.22.4	3 x 400	2.9	2.2	5.3	1460
SLV.80.80.40.4	3 x 400	4.8	4.0	9.7	1460
SLV.80.80.40.2	3 x 400	4.8	4.0	8.5	2930
SLV.80.80.60.2	3 x 400	6.9	6.0	12.5	2940
SLV.80.80.75.2	3 x 400	8.7	7.5	15.1	2920
SLV.80.80.92.2	3 x 400	10.5	9.2	18.0	2960
SLV.80.80.110.2	3 x 400	12.5	11.0	21.4	2950

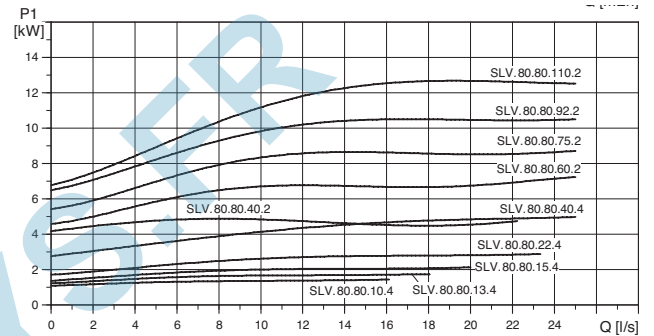

Type de pompe	Dimensions [mm]															
	A	C	D	E	F	H	DN1	Dc1	Dt1	DØ1	D1n	DN2	Dc2	Dt2	DØ2	D2n
SLV.80.80.11.4	711	409	171	241	339	109	80	160	20	8 x 18	80	160	20	8 x 18	94	
SLV.80.80.13.4	711	409	171	241	339	109	80	160	20	8 x 18	80	160	20	8 x 18	94	
SLV.80.80.15.4	711	409	171	241	339	109	80	160	20	8 x 18	80	160	20	8 x 18	94	
SLV.80.80.22.4	711	409	171	241	339	109	80	160	20	8 x 18	80	160	20	8 x 18	106	
SLV.80.80.40.4	744	456	200	276	380	104	80	160	20	8 x 18	80	160	20	8 x 18	121	
SLV.80.80.40.2	748	460	200	267	393	109	80	160	20	8 x 18	80	160	20	8 x 18	134	
SLV.80.80.60.2	751	456	200	276	380	104	80	160	20	8 x 18	80	160	20	8 x 18	140	
SLV.80.80.75.2	751	456	200	276	380	104	80	160	20	8 x 18	80	160	20	8 x 18	141	
SLV.80.80.75.2	751	456	200	276	380	104	80	160	20	8 x 18	80	160	20	8 x 18	141	
SLV.80.80.110.2	782	489	217	293	413	123	80	160	20	8 x 18	80	160	20	8 x 18	183	

Type de pompe	Dimensions [mm]															
	Z2	Z3	Z4	Z6	Z7	Z8	Z9	Z11	Z12a	Z14	Z15	Z16	Z10	Dc1	DN1	ZM
SLV.80.80.11.4	220	95	160	762	569	402	81	802	91	13	171	345	1 1/2"	160	80	4 x M16
SLV.80.80.13.4	220	95	160	762	569	402	81	802	91	13	171	345	1 1/2"	160	80	4 x M16
SLV.80.80.15.4	220	95	160	762	569	402	81	802	91	13	171	345	1 1/2"	160	80	4 x M16
SLV.80.80.22.4	220	95	160	762	569	402	81	802	91	13	171	345	1 1/2"	160	80	4 x M16
SLV.80.80.40.4	220	95	160	809	617	437	81	840	96	13	171	345	1 1/2"	160	80	4 x M16
SLV.80.80.40.2	220	95	160	813	620	428	81	839	91	13	171	345	1 1/2"	160	80	4 x M16
SLV.80.80.60.2	220	95	160	809	617	437	81	840	96	13	171	345	1 1/2"	160	80	4 x M16
SLV.80.80.75.2	220	95	160	809	617	437	81	847	96	13	171	345	1 1/2"	160	100	4 x M16
SLV.80.80.92.2	220	95	160	842	650	454	81	858	77	13	171	345	1 1/2"	160	100	4 x M16
SLV.80.80.110.2	220	95	160	842	650	454	81	858	77	13	171	345	1 1/2"	160	100	4 x M16

Type de pompe	Dimensions [mm]							
	V1	V2	V3	V4	V5	V6	V7	VØ
SLV.80.80.11.4	839	379	128	330	280	527	80	18
SLV.80.80.13.4	839	379	128	330	280	527	80	18
SLV.80.80.15.4	839	379	128	330	280	527	80	18
SLV.80.80.22.4	839	379	128	330	280	527	80	18
SLV.80.80.40.4	872	374	128	330	280	574	80	18
SLV.80.80.40.2	876	379	128	330	280	578	80	18
SLV.80.80.60.2	879	374	128	330	280	574	80	18
SLV.80.80.75.2	879	374	128	330	280	574	80	18
SLV.80.80.92.2	910	393	128	330	280	607	80	18
SLV.80.80.110.2	910	393	128	330	280	607	80	18

Plage de performances

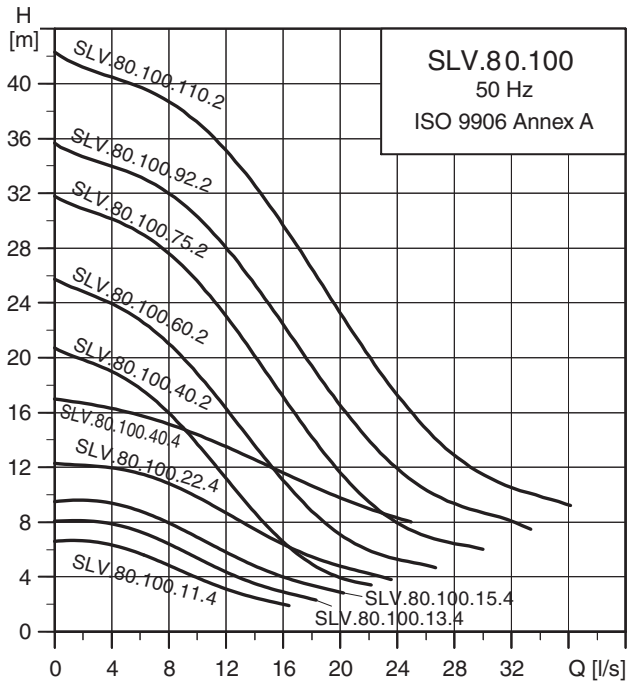

Caractéristiques électriques

Type de pompe	Tension [V]	P1 [kW]	P2 [kW]	I _n [A]	n [min-1]
SLV.80.100.11.4	3 x 400	1.5	1.1	3.0	1450
SLV.80.100.13.4	3 x 400	1.8	1.3	3.6	1460
SLV.80.100.15.4	3 x 400	2.1	1.5	3.9	1450
SLV.80.100.22.4	3 x 400	2.9	2.2	5.3	1460
SLV.80.100.40.4	3 x 400	4.8	4.0	9.7	1460
SLV.80.100.40.2	3 x 400	4.8	4.0	8.5	2930
SLV.80.100.60.2	3 x 400	6.9	6.0	12.5	2940
SLV.80.100.75.2	3 x 400	8.7	7.5	15.1	2920
SLV.80.100.92.2	3 x 400	10.5	9.2	18.0	2960
SLV.80.100.110.2	3 x 400	12.5	11.0	21.4	2950

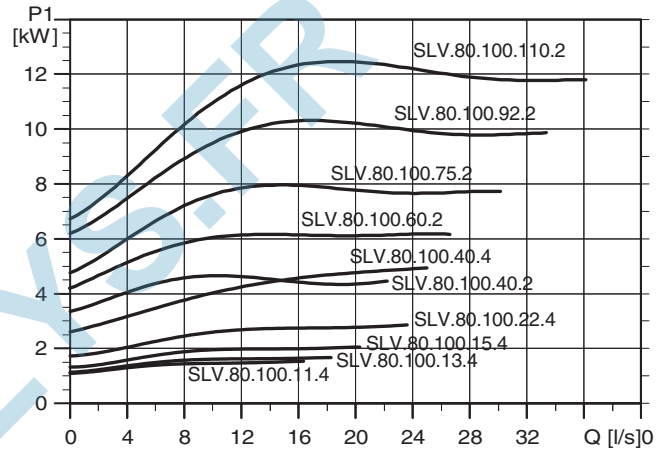

Type de pompe	Dimensions [mm]																
	A	C	D	E	F	H	DN1	Dc1	Dt1	DØ1	D1n	DN2	Dc2	Dt2	DØ2	D2n	Poids
SLV.80.100.11.4	711	407	171	241	336	109	80	160	20	8 x 18	80	180	20	8 x 18	94		
SLV.80.100.13.4	711	407	171	241	336	109	80	160	20	8 x 18	80	180	20	8 x 18	94		
SLV.80.100.15.4	711	407	171	241	336	109	80	160	20	8 x 18	80	180	20	8 x 18	94		
SLV.80.100.22.4	711	407	171	241	336	109	80	160	20	8 x 18	80	180	20	8 x 18	106		
SLV.80.100.40.4	744	466	200	286	380	104	80	160	20	8 x 18	80	180	20	8 x 18	121		
SLV.80.100.40.2	748	458	200	267	391	109	80	160	20	8 x 18	80	180	20	8 x 18	134		
SLV.80.100.60.2	751	466	200	286	380	108	80	160	20	8 x 18	80	180	20	8 x 18	140		
SLV.80.100.75.2	782	499	217	303	413	123	80	160	20	8 x 18	80	180	20	8 x 18	141		
SLV.80.100.92.2	782	499	217	303	413	123	80	160	20	8 x 18	80	180	20	8 x 18	183		
SLV.80.100.110.2	782	499	217	303	413	123	80	160	20	8 x 18	80	180	20	8 x 18	183		
Type de pompe	Dimensions [mm]																
	Z2	Z3	Z4	Z6	Z7	Z8	Z9	Z11	Z12a	Z14	Z15	Z16	Z10	Dc1	DN1	ZM	
SLV.80.100.11.4	260	110	270	850	624	458	110	842	131	0	220	413	2"	180	100	4 x M16	
SLV.80.100.13.4	260	110	270	850	624	458	110	842	131	0	220	413	2"	180	100	4 x M16	
SLV.80.100.15.4	260	110	270	850	624	458	110	842	131	0	220	413	2"	180	100	4 x M16	
SLV.80.100.22.4	260	110	270	850	624	458	110	842	131	0	220	413	2"	180	100	4 x M16	
SLV.80.100.40.4	260	110	270	909	683	503	110	876	132	0	220	413	2"	180	100	4 x M16	
SLV.80.100.40.2	260	110	270	901	675	484	110	857	109	0	220	413	2"	180	100	4 x M16	
SLV.80.100.60.2	260	110	270	909	683	503	110	883	132	0	220	413	2"	180	100	4 x M16	
SLV.80.100.75.2	260	110	270	942	716	520	110	899	117	0	220	413	2"	180	100	4 x M16	
SLV.80.100.92.2	260	110	270	942	716	520	110	899	117	0	220	413	2"	180	100	4 x M16	
SLV.80.100.110.2	260	110	270	942	716	520	110	899	117	0	220	413	2"	180	100	4 x M16	
Type de pompe	Dimensions [mm]																
	V1	V2	V3	V4	V5	V6	V7	VØ									
SLV.80.100.11.4	839	354	128	330	280	549	100	18									
SLV.80.100.13.4	812	369	130	355	300	591	100	18									
SLV.80.100.15.4	812	369	130	355	300	591	100	18									
SLV.80.100.22.4	812	369	130	355	300	591	100	18									
SLV.80.100.40.4	878	395	130	355	300	647	100	18									
SLV.80.100.40.2	876	354	128	330	280	600	100	18									
SLV.80.100.60.2	879	353	128	330	280	598	100	18									
SLV.80.100.40.2	876	354	128	330	280	600	100	18									
SLV.80.100.60.2	879	353	128	330	280	598	100	18									
SLV.80.100.110.2	910	393	128	330	280	607	80	18									

Plage de performances

Caractéristiques électriques

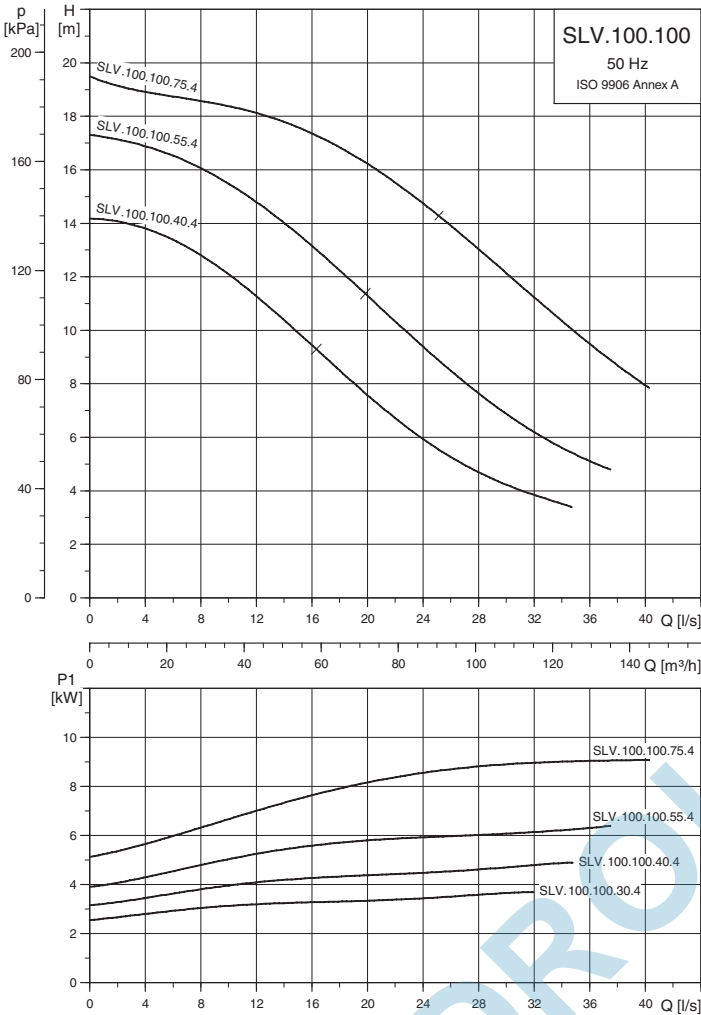

Type de pompe	Tension [V]	P1 [kW]	P2 [kW]	I _{1/1} [A]	n [min-1]
SLV.100.100.30.4	3 x 400	3.7	3.0	7.2	1450
SLV.100.100.40.4	3 x 400	4.8	4.0	9.7	1460
SLV.100.100.55.4	3 x 400	6.4	5.5	11.8	1460
SLV.100.100.75.4	3 x 400	8.6	7.5	15.2	1460

Type de pompe	Dimensions [mm]															
	A	C	D	E	F	H	DN1	Dc1	Dt1	DØ1	D1n	DN2	Dc2	Dt2	DØ2	D2n
SLV.100.100.30.4	737	457	200	277	380	134	100	180	20	8 x 18	100	180	180	20	8 x 18	125
SLV.100.100.40.4	759	457	200	277	380	134	100	180	20	8 x 18	100	180	180	20	8 x 18	130
SLV.100.100.55.4	766	457	200	277	380	134	100	180	20	8 x 18	100	180	180	20	8 x 18	136
SLV.100.100.75.4	842	490	217	294	413	145	100	180	20	8 x 18	100	180	180	20	8 x 18	179

Type de pompe	Dimensions [mm]															
	Z2	Z3	Z4	Z6	Z7	Z8	Z9	Z11	Z12a	Z14	Z15	Z16	Z10	Dc1	DN1	ZM
SLV.100.100.30.4	260	110	270	900	674	494	110	844	106	0	220	413	2"	180	100	4 x M16
SLV.100.100.40.4	260	110	270	900	674	494	110	866	106	0	220	413	2"	180	100	4 x M16
SLV.100.100.55.4	260	110	270	900	674	494	110	873	106	0	220	413	2"	180	100	4 x M16
SLV.100.100.75.4	260	110	270	933	707	511	110	938	95	0	220	413	2"	180	100	4 x M16

Type de pompe	Dimensions [mm]							
	V1	V2	V3	V4	V5	V6	V7	VØ
SLV.100.100.30.4	867	411	130	355	300	599	100	19
SLV.100.100.40.4	889	411	130	355	300	599	100	19
SLV.100.100.55.4	896	411	130	355	300	599	100	19
SLV.100.100.75.4	972	422	130	355	300	632	100	19